

המכללה  
הטכנולוגית  
באר שבע

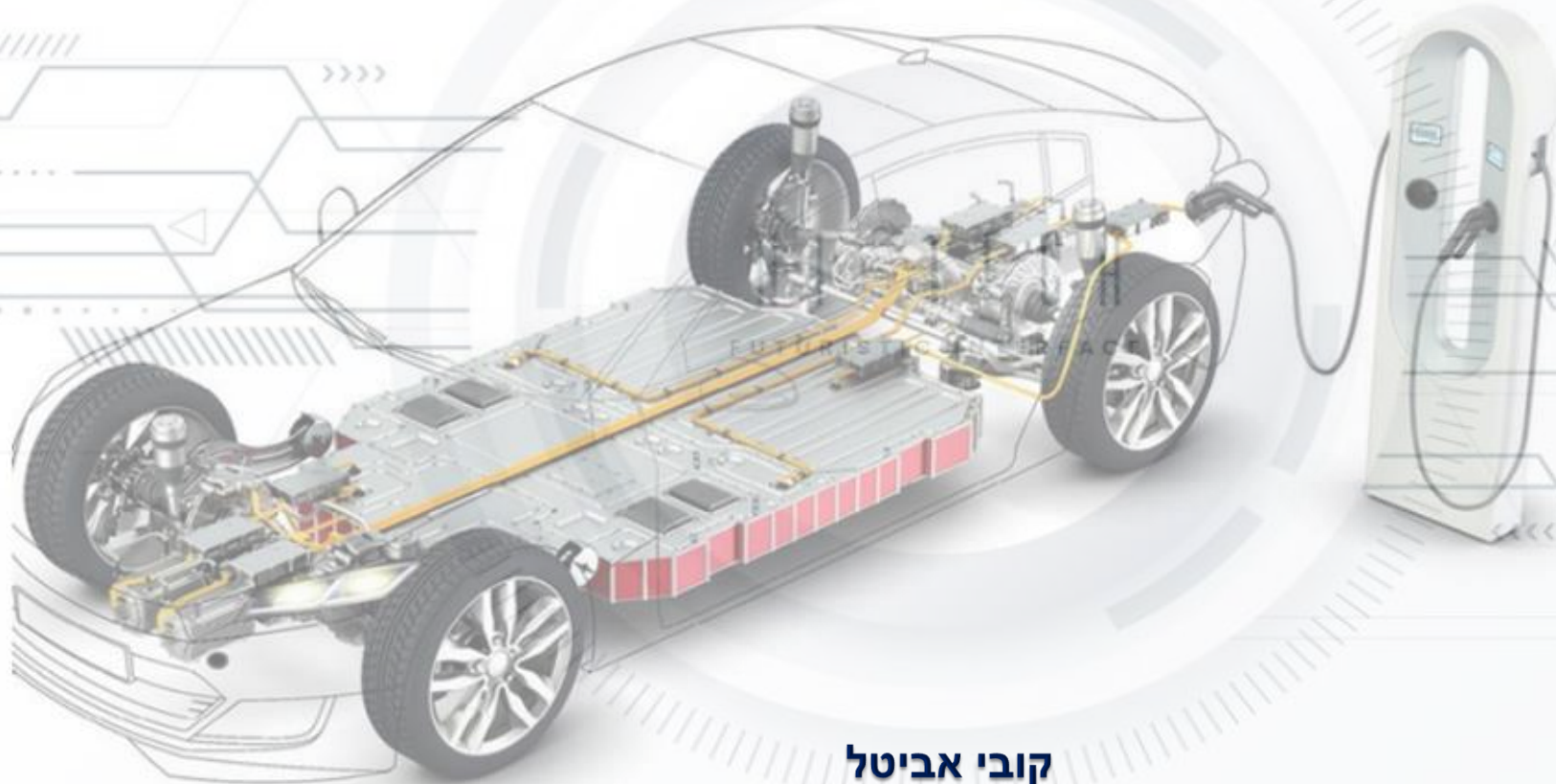

# האוטוטק הישראלי בחזית הפיתוח העולמי



קובי אביטל  
סמנכ"ל מו"פ

חדשנות טכנולוגית ברכב ותחבורה חכמה

אוגוסט 2024



# 1950

## Low-tech



**מכונית הנוסעים הטובה באירופה**

מודל מסובכלל:  
4 דלתות, סנוף מהלכים בגלגל ההנהגה  
למכירה ברשיון  
מאת המספק על התעבורה בדרכים

המפיצים היחידים בישראל:

**פ ל מ ה**

סוכנות ארץ-ישראלית  
לאוטומובילים בע"מ  
השדר הראשי:

תל-אביב, רחוב אחוות בית ג.  
סלסון 3869, ת.ד. 5005  
תחנת שרות חוסר מלחה  
ל-אביב, נכפת הרצל

**הגיע לישראל**  
**ŠKODA 1950**



# ענף תחזוקת הרכב במחצית המאה הקודמת

1970



ענף תחזוקת הרכב בשנות ה-70 של המאה הקודמת



1990

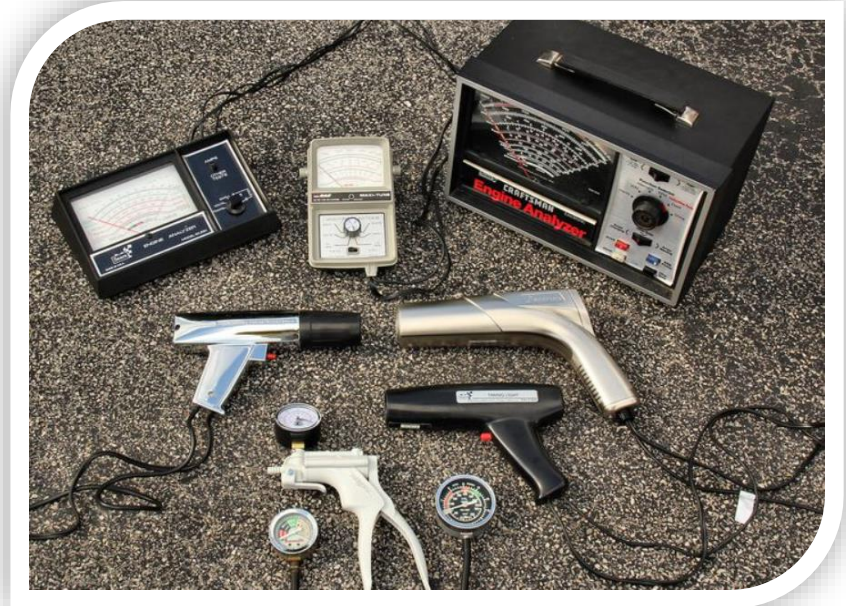

מבדיקת מנוע - לדיאגנוסטיקה



# 2000

Mid-tech



ראשית המאה ה-21, דיאגנוסטיקה דיגיטלית

2010

# The 4th Industrial Revolution



המהפכה התעשייתית ה-4

# Enter into the 4<sup>th</sup> Industrial Revolutio

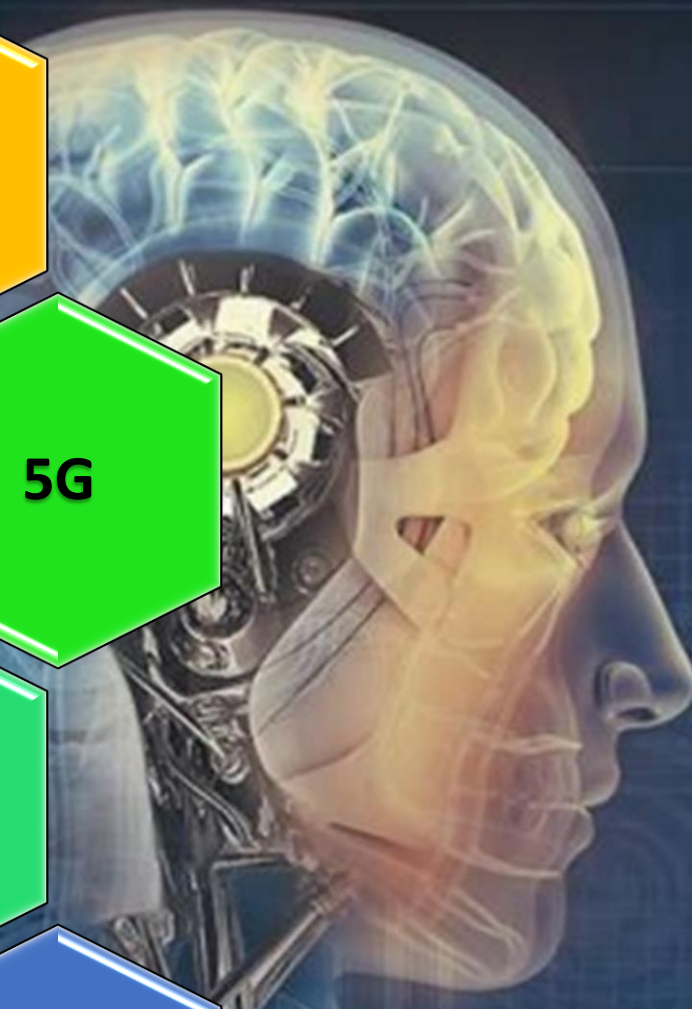

# תחבורה חכמה

## למה?

INDUSTRY 4.0 





# עובדות ונתונים אמפיריים-1



1.3 מיליון הרוגים בממוצע בשנה אחת  
מתאונות דרכים

גורם המוות: נהגים צעירים בגילאי 18-  
29

סיבת התאונה במעל מ-90% מהמקרים-  
הגורם האנושי

**WORLD HEALTH ORGANIZATION**

# עובדות ונתונים אמפיריים-11



60% מאוכלוסיית העולם  
מתגוררת במרכזי הערים

כ- 2 מיליארד כלי רכב נעים  
בכבישי העולם

30% מהפקקים בעיר נגרמים  
מחיפוש חנייה

כ-95% מהזמן הרכבים  
הפרטיים עומדים/חונים בחנייה

# CO2 EMISSIONS IN THE EU

## Evolution of CO2 emissions by sector (1990-2016)

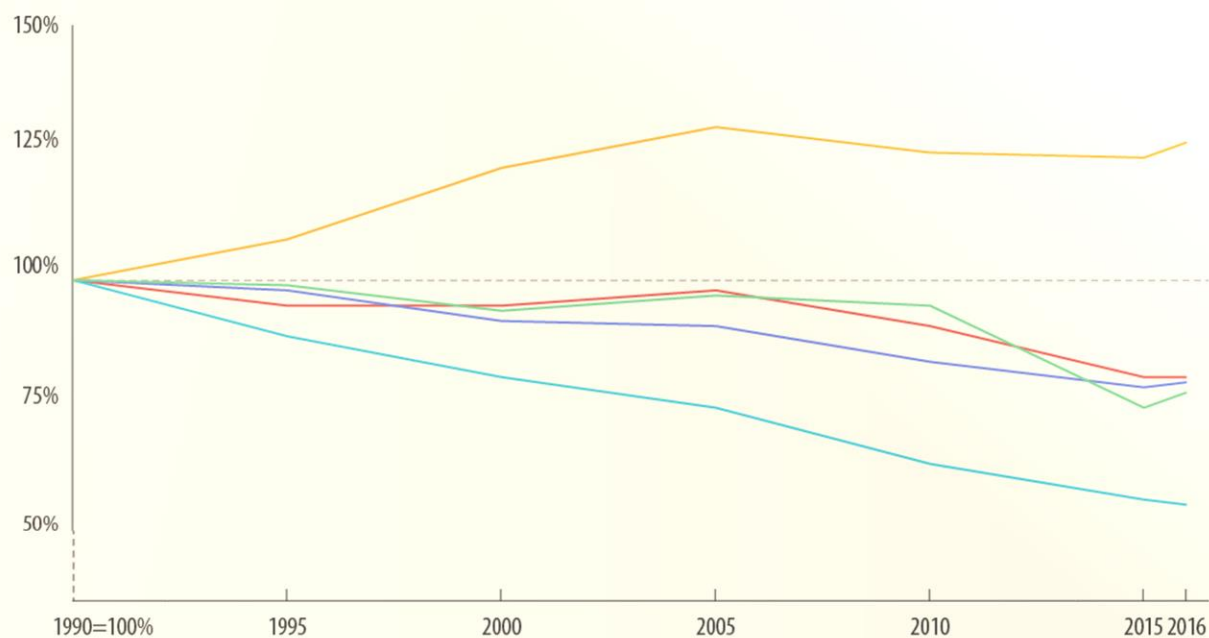

**לפי ממצאי הארגון העולמי  
לאיכות הסביבה-  
הגורם המרכזי לזיהום האוויר בכלל  
ובמרכזי הערים בפרט הוא:**

**התחבורה**



**אז...**

**תאונות  
דרכים**

**זיהום אוויר**

**גודש  
תנועה**

**חיי אדם  
ואיכות  
חיים**



# The 4th Industrial Revolution

**המעבר לתחבורה חכמה אינו שאלה  
של האם ? או מתי ?  
אלא, איך עושים את זה נכון**

**המסקנה: שטכנולוגיות המהפכה הרביעית מסוגלות לייצר  
פתרונות למצוקות הנ"ל.**



חז"ל "איזהו חכם הרואה את הנולד"

# משרד ראש הממשלה



החלטות ממשלה

## הפחתת התלות הישראלית בנפט בתחבורה

מספר החלטה: 5327

ממשלה: הממשלה ה-32, בנימין נתניהו  
תאריך עדכון: 18.09.2017

יחידה: מזכירות הממשלה  
תאריך פרסום: 13.01.2013

החלטה מספר 5327 של הממשלה מיום **13.01.2013**



משרד ראש הממשלה



החלטות ממשלה  
**תכנית לאומית לתחבורה חכמה**

מספר החלטה: 2316

ממשלה: הממשלה ה-34, בנימין נתניהו  
תאריך עדכון: 19.09.2017

יחידה: מזכירות הממשלה  
תאריך פרסום: 22.01.2017

קבצים רלוונטים להורדה

החלטה מספר 2316 של הממשלה מיום 22.01.2017







The  
**Smart Mobility**  
Initiative

אוניברסיטת  
בר-אילן  
Bar-Ilan University



# המרכז הישראלי למחקר בתחבורה חכמה



משרד התחבורה  
והבטיחות בדרכים



משרד ראש הממשלה

התכנית הלאומית  
לתחבורה חכמה



2017



הדרך

לתחבורה חכמה

בישראל

לשכת מנכ"לית משרד התחבורה והבטיחות בדרכים



**Global AutoTech**



**Innovation Leading**



**700 Auto-Tech companies and Startups**

**700 חברות וסטארט-אפ**



**6 Automotive R&D Centers in Israel**

**6 מרכזי מו"פ ברכב בישראל**

R&D Center in Israel  
מו"פ בישראל



Volkswagen

**KONNECT**  
VOLKSWAGEN GROUP INNOVATION TEL AVIV

Geektime  
**Smart Mobility  
in Israel**



**R&D Center in Israel**  
**מו"פ בישראל**



**GENERAL MOTORS**  
**Israel Tech Center**

**Key Brands of General Motors**

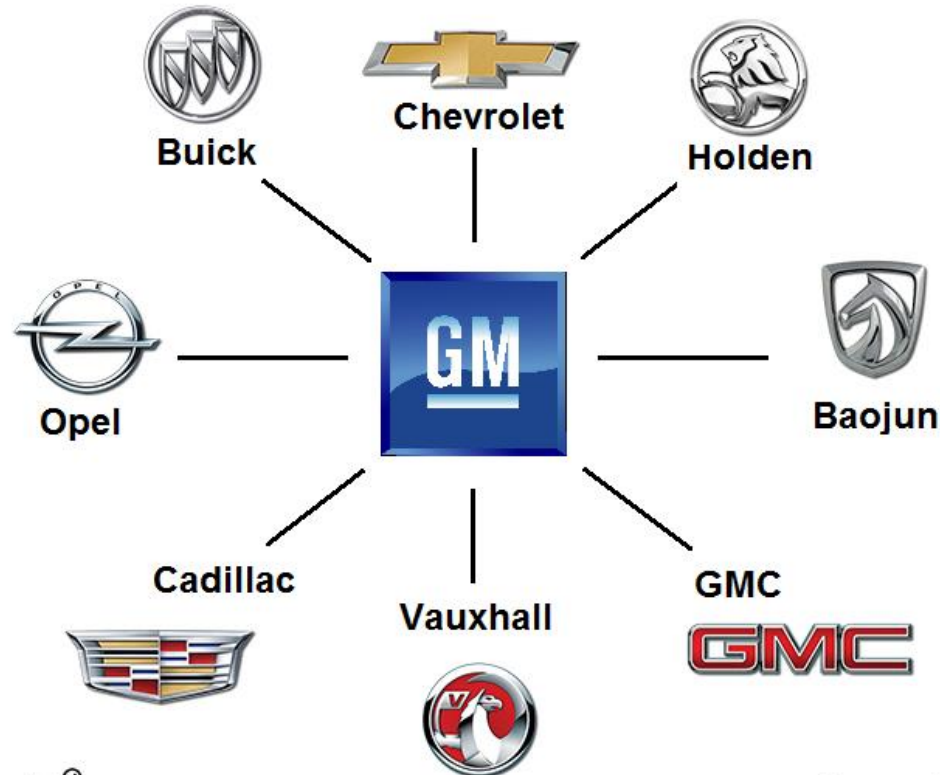



R&D Center in Israel  
מו"פ בישראל



Mercedes-Benz  
DAIMLER



**R&D Center in Israel**  
**מו"פ בישראל**



**Automotive Cybersecurity**  
**R&D**

R&D Center in Israel  
מו"פ בישראל



Honda, Volvo, Hertz and Ituran are partners in the DRIVE innovation hub in Tel Aviv founded by Mayer Group, the Israeli importer of Honda and Volvo cars.

PARTNERS  
▶▶



# Innovation Lab in Israel

## מעבדת חדשנות בישראל



RENAULT NISSAN MITSUBISHI

Renault, Nissan, Mitsubishi alliance launch Tel Aviv innovation lab



From left: IIA CEO Aharon Aharon, Tel Aviv executive vice president Gaspar Gascor



**RENAULT**

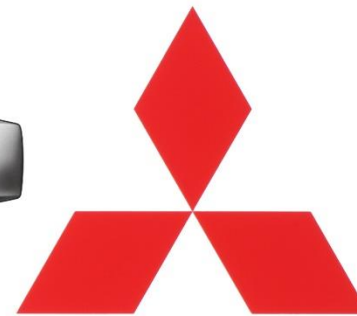

**mitsubishi**

**Innovation Lab in Israel**  
**מעבדת חדשנות בישראל**



# ZERO Traffic Jam



# איך יוצרים תשתיות לתחבורה חכמה?

**כבישים ורמזורים עם תשתיות דיגיטליות:**  
RSU,CAM,RADAR,AI

**מפת דרכים דיגיטלית- Road Map/  
HD Maps**

**תשתיות תקשורת סלולרית C-V2X  
תקשורת אינטרנט 5G, IOT, OTA**

**רכבים חכמים:** יכולות חישה גבוהות, עיבוד נתונים מהיר,  
בינה מלכותית, מוגן סייבר והנעה באנרגיה ירוקה



# Road Map

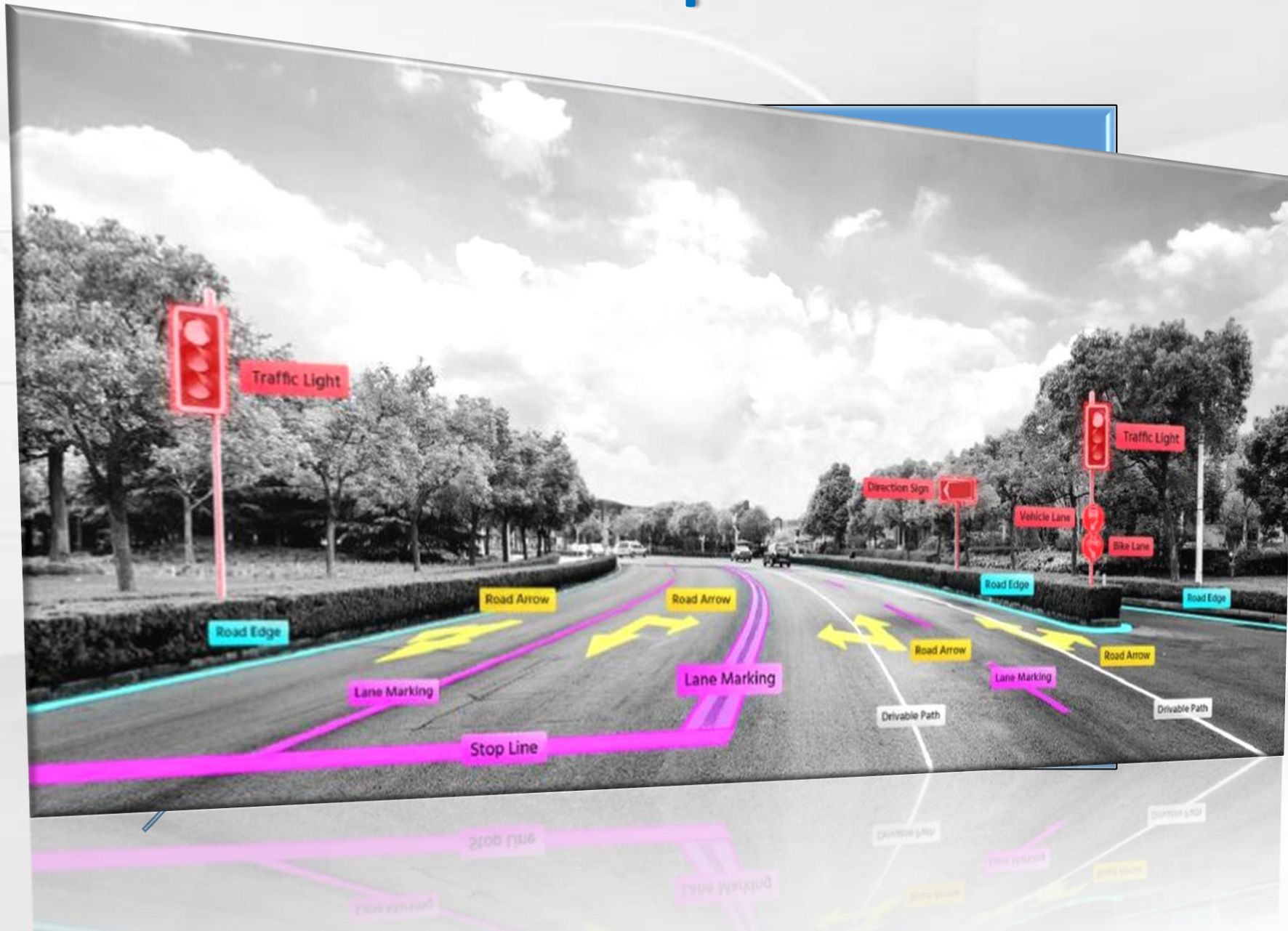



# Google

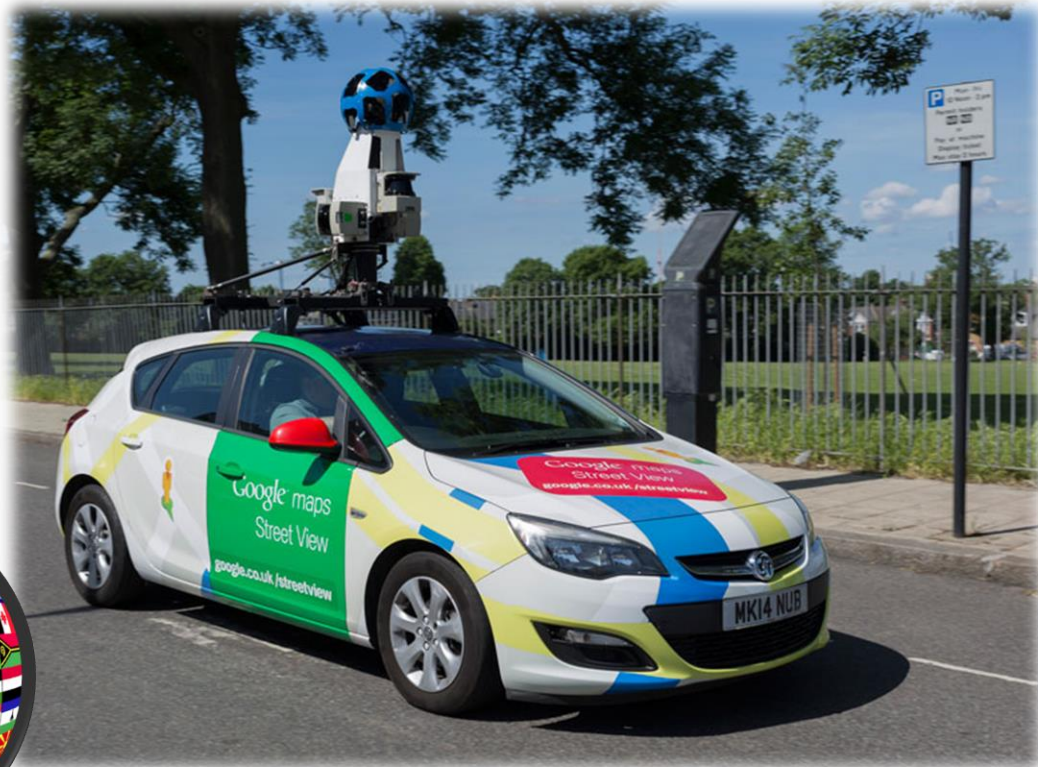

# Google



# הטכנולוגיה של אינטל - מובילאי

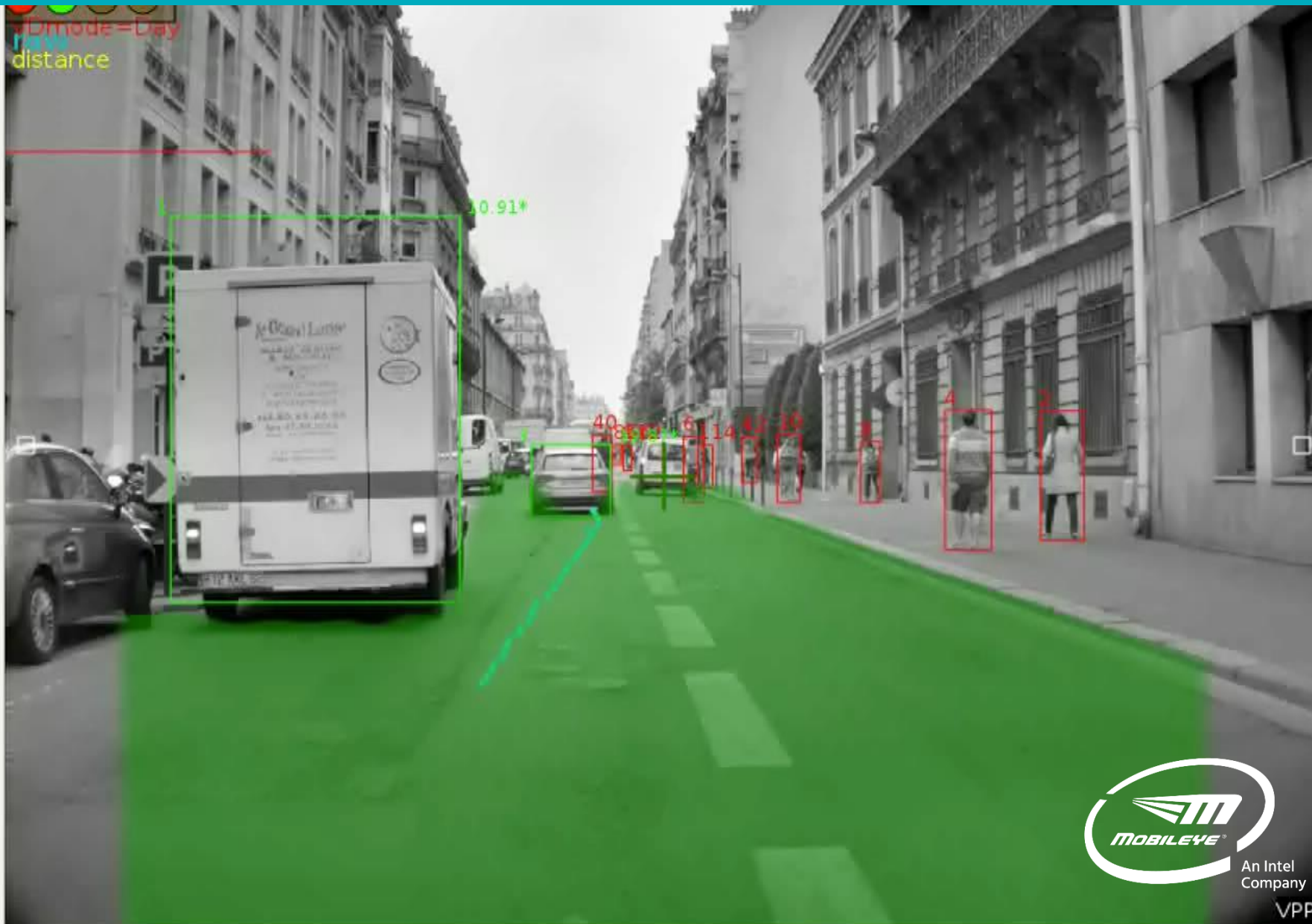
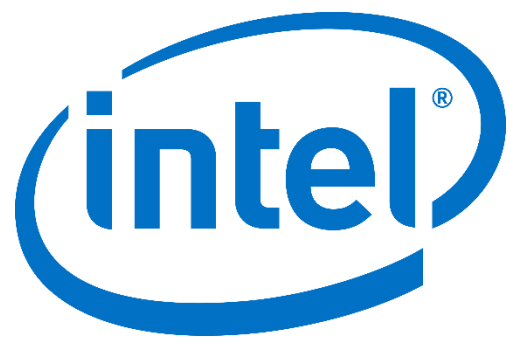

# The end product

RB data projected onto image space.  
Road edge, lane marks, lane center, landmarks (in Yellow)

RB data projected onto Google Earth

103 45809 [main] [itm] [main] map2trk



103 45809 [main] [itm] [map\_view] map2trk





# Smart Sensors

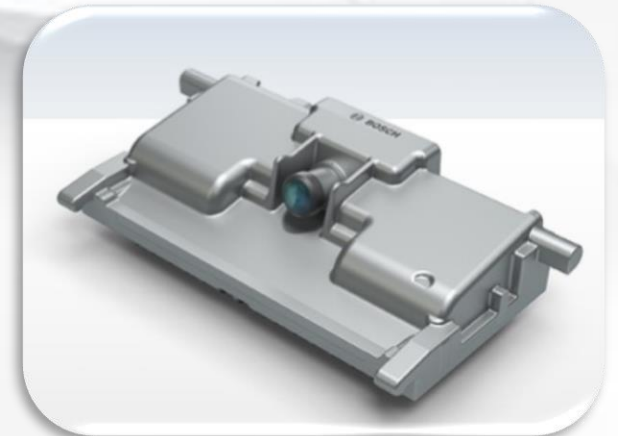



# Smart Sensors – Front Camera

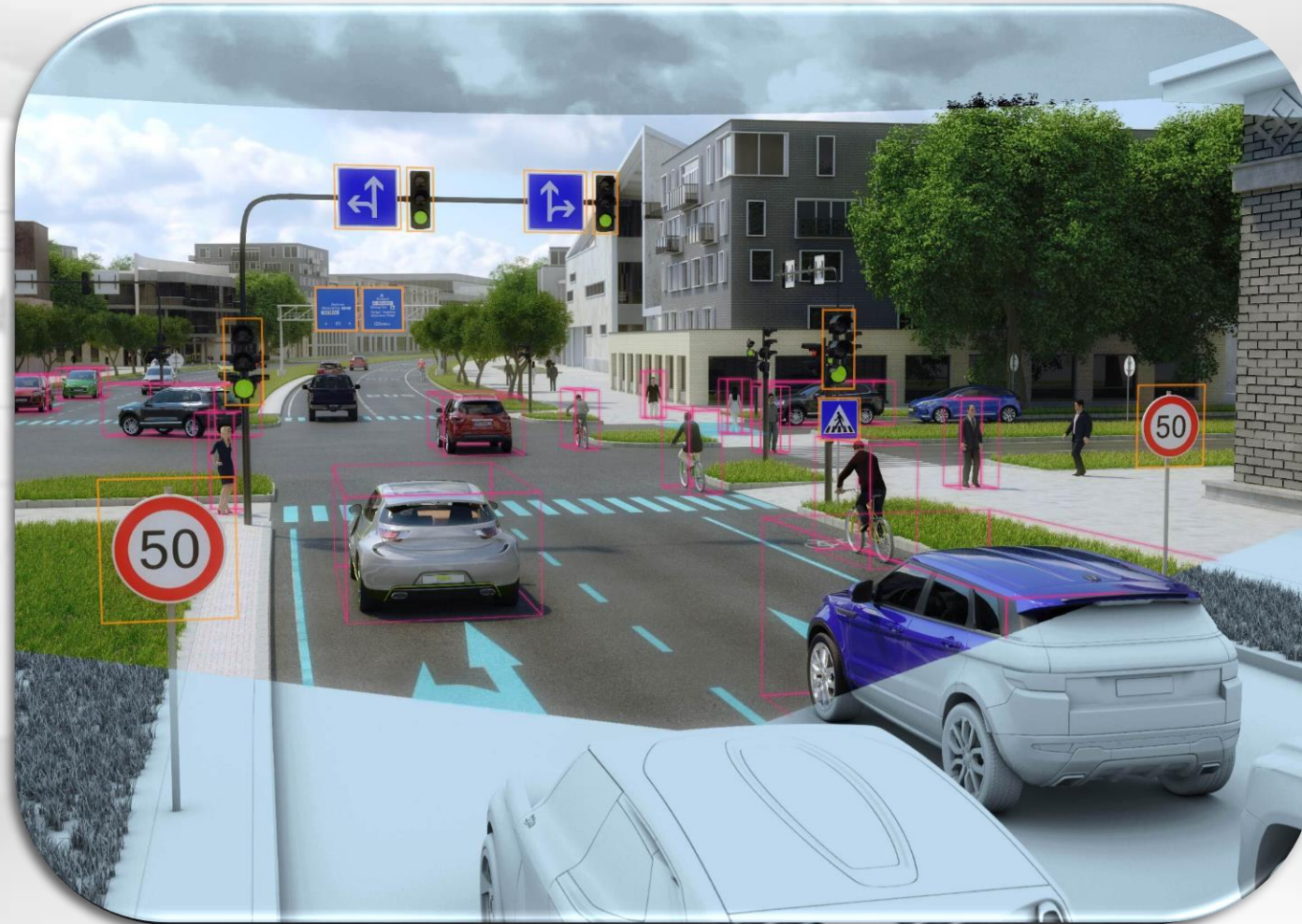



# Smart Sensors: Camera



TRIEYE®



מהי המגבלה המשמעותית של המצלמה?





כיצד יזהה חיישן המצלמה הקדמי את התמרור בצד ימין?

כיצד יזהה חיישן המצלמה הקדמי את סימוני שולי הכביש?





# Smart Sensors- Lidar

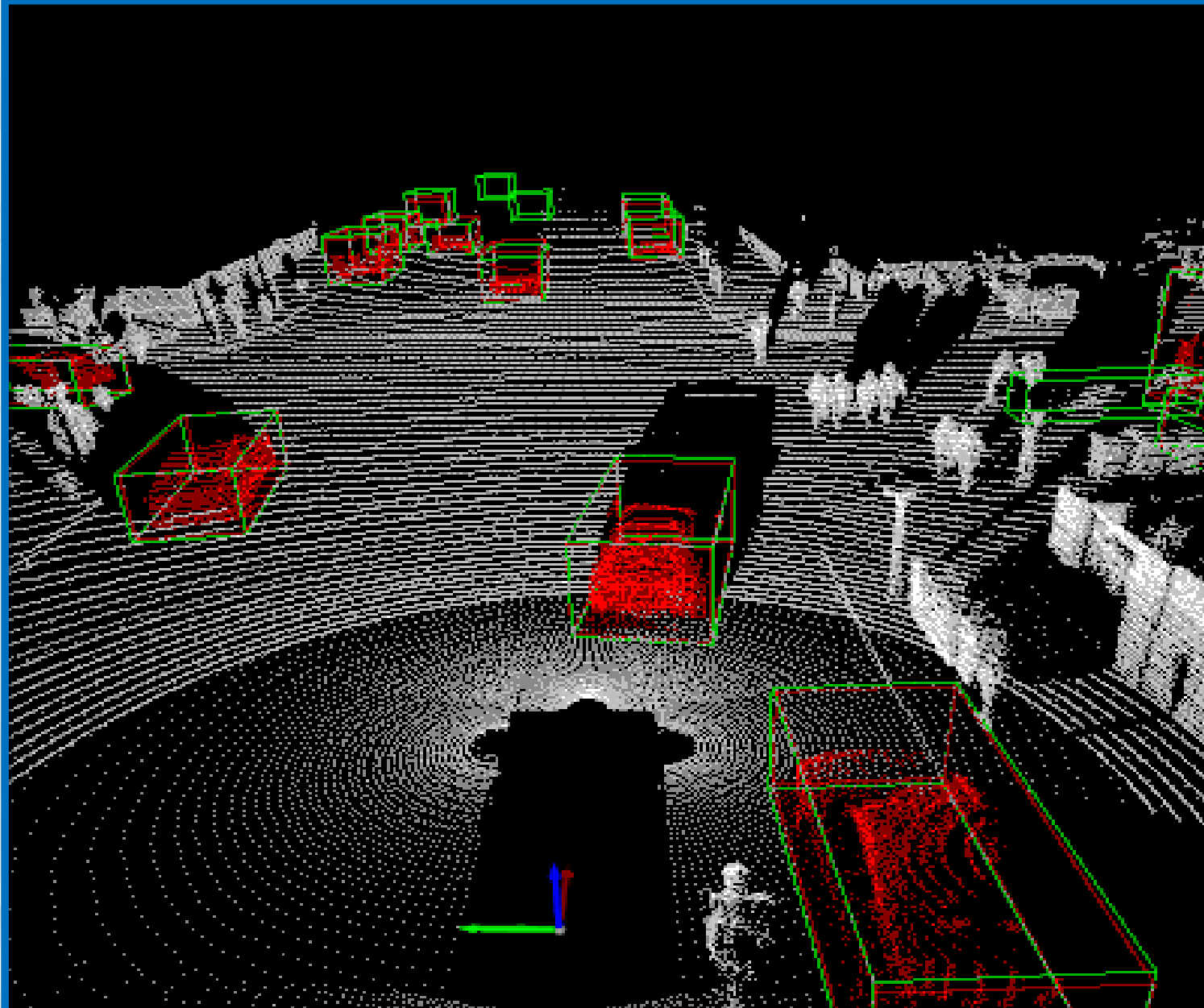





# Smart Sensors: Radar





# Cyber Security





# Automotive Cyber Attack Vectors



**INFOTAINMENT**

**TELEMATICS**

**SECURITY**

**OBD II**

**ECUs**

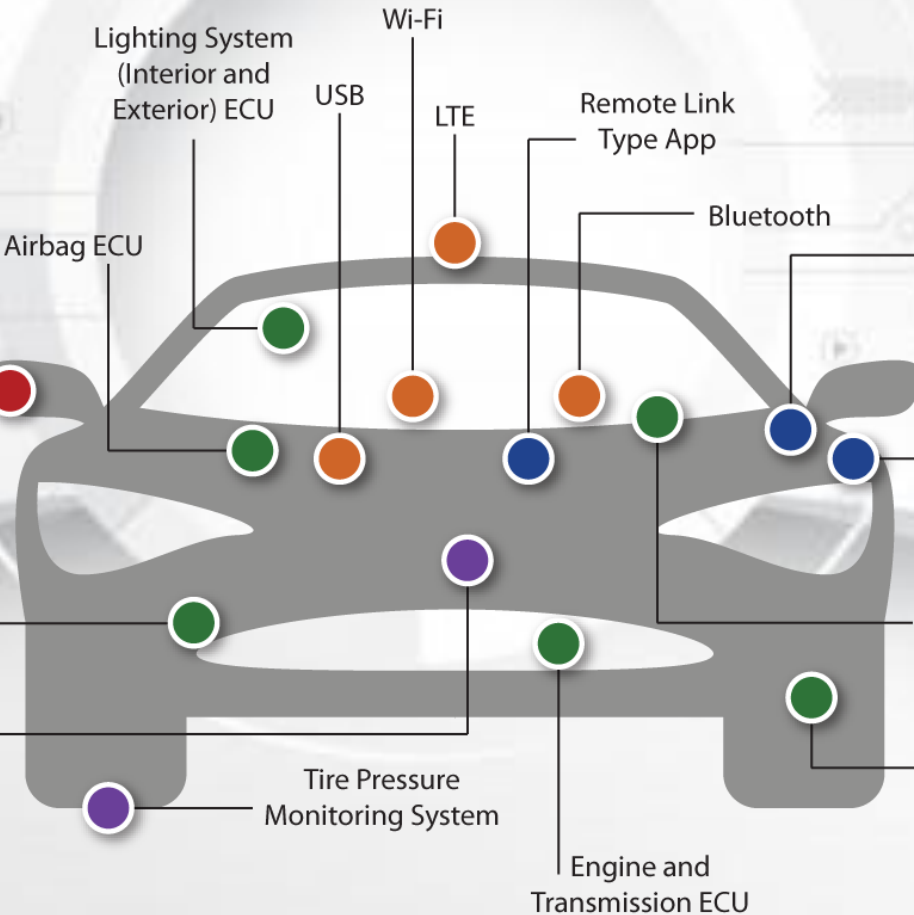



# Cyber Security

**Upstream.auto**  
Securing Smart Mobility



**ARGUS**  
CYBER SECURITY

**ENIGMATOS**  
Automotive Cyber Security



**REGULUS**



**CYMOCTIVE**  
TECHNOLOGIES

# מערך הסייבר לתחבורה חכמה בישראל



**CyITS**

מרכז הסייבר הלאומי  
לתחבורה חכמה

Israel Cyber Center  
for Intelligent  
Transportation System



משרד התחבורה  
והבטיחות בדרכים  
אגף הסייבר





# Hi-Tech 2023



**המאה ה-21, לייב-דיאגנוסטיק ועדכוני תוכנה מרחוק**

# OTA



# 2023



# OTA



TESLA

TESLA

- 01:55 Tesla  
Software update is complete.
- 01:18 Tesla  
Software update is about to begin. You can cancel the update from the Tesla...
- 00:22 Tesla  
Software update is available.



TESLA

TESLA

# 2023







OTA





# EV-electric vehicle batteries



**R3E**



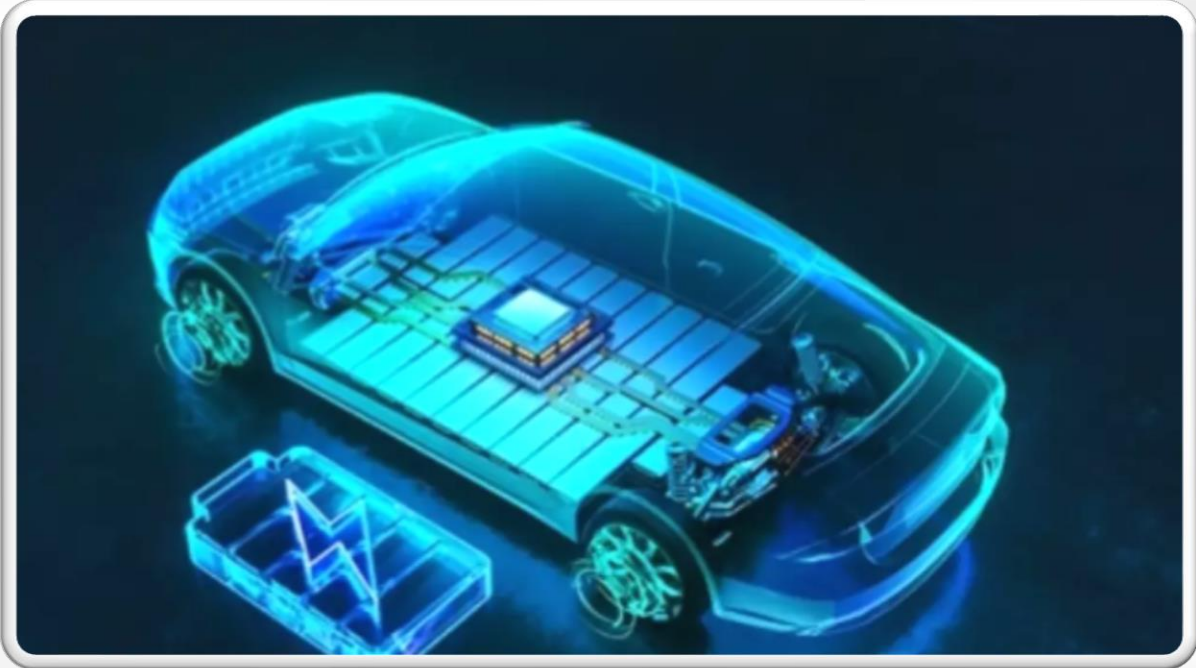

# electreon

Charging the way forward



## Wireless Dynamic Charging Roads



המכללה  
הטכנולוגית  
באר שבע



המכללה  
הטכנולוגית  
באר שבע  
בשיתוף WORLD ORT  
קדימה מדע



## תנו גזל EXTRA קריירה



לומדים הנדסת רכב ומקבלים

# תואר! תואר!



תעודת הכשרה  
מתקדמת  
ברכב חשמלי  
של איגוד המוסכים (L4)



תואר  
הנדסאי רכב  
של המכללה הטכנולוגית  
באר שבע

ללמוד לתואר במכללה  
הטכנולוגית ב"ש



# מסלול קידום בענף



הנדסאי רכב

אוטוטק  
מנהל מקצועי

אוטוטרניקה  
מתקדמים

אוטוטרניקה  
רמה א'



**תעודות**



המכללה  
הטכנולוגית  
באר שבע





משרד התחבורה  
והבטיחות בדרכים

# מדרג הסמכות ברכבי מתח גבוה





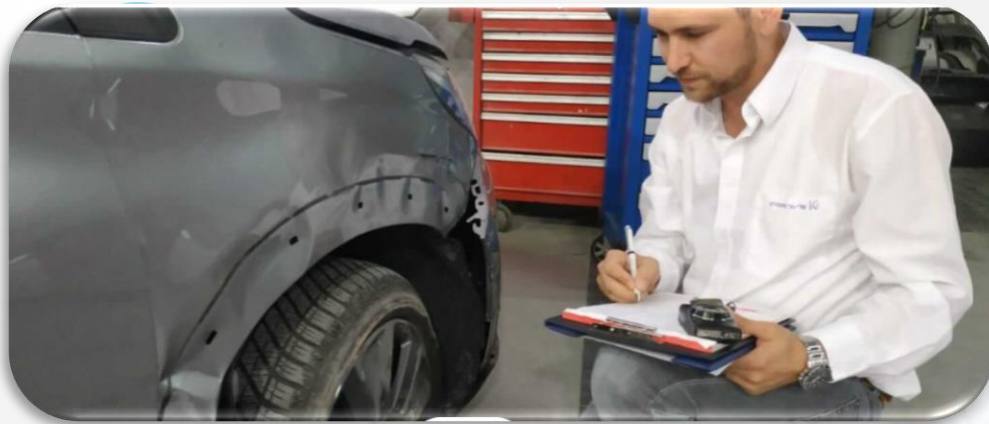

שמאי  
רכב

יועצת/ץ  
שירות



אפיקי  
תעסוקה  
וקריירה

אוטוטק



מאבחנת/ן  
תקלות





**מנהל/ת**  
**מרכז שירות**



ANY  
QUESTIONS



*Kobi Avital*

